

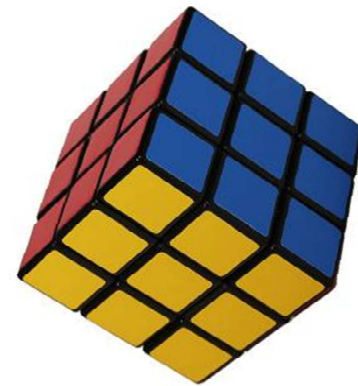

LES SOLIDES

LE CUBE

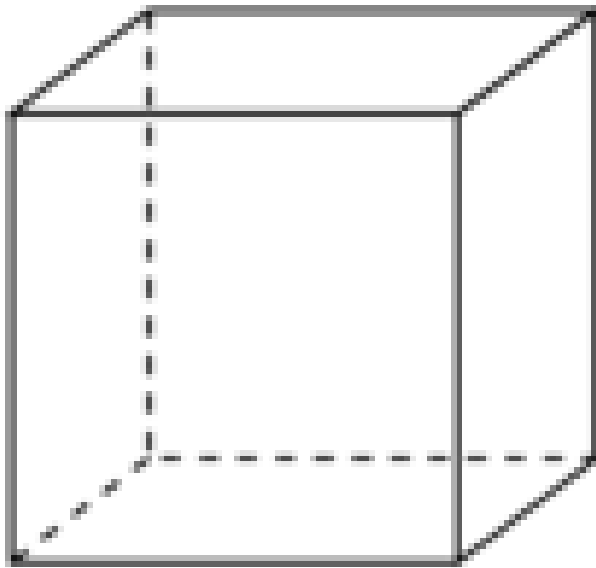

LE CUBE

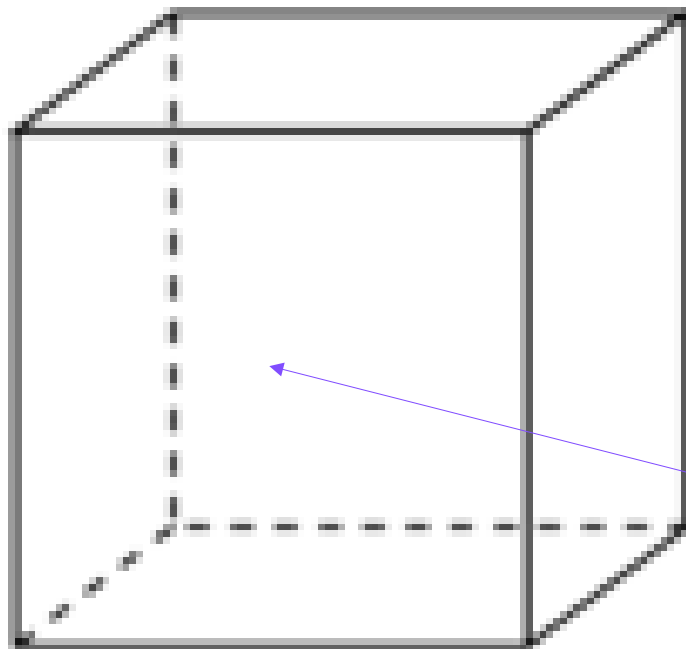

Un sommet

Une arête

Une face

LE PAVE

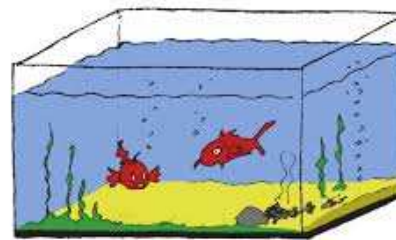
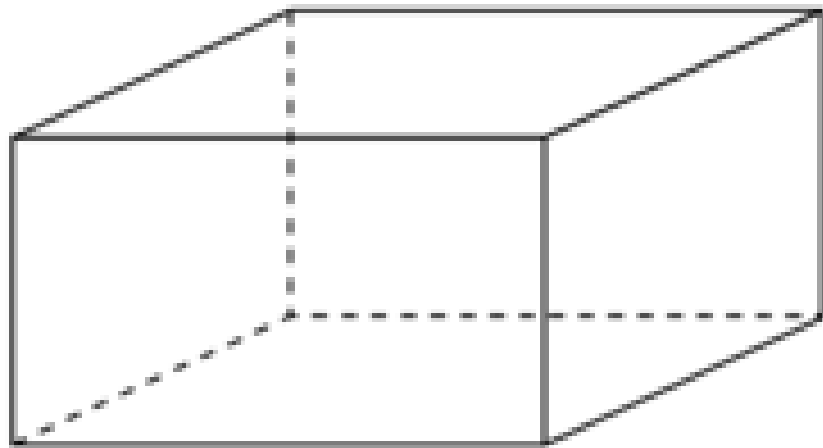

LE PAVE

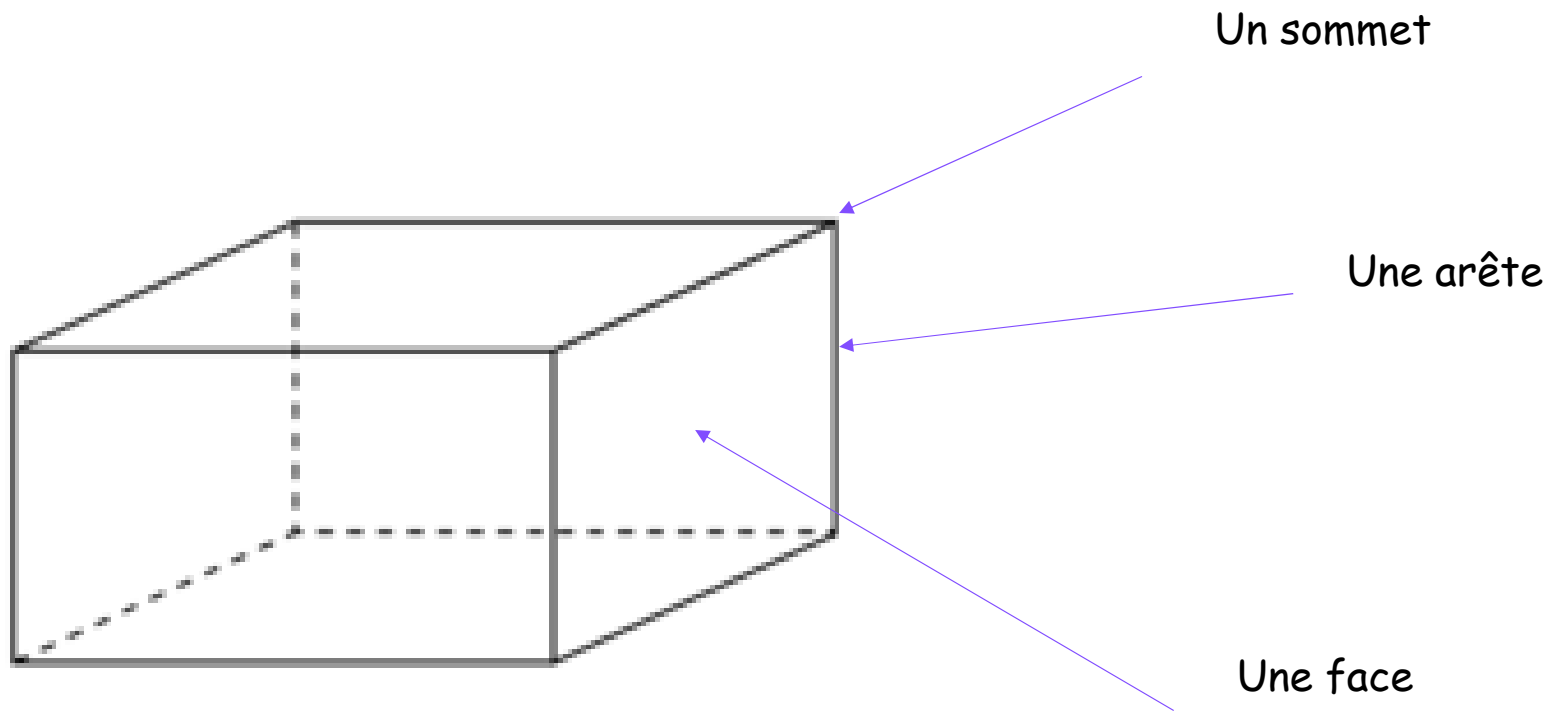

LA BOULE

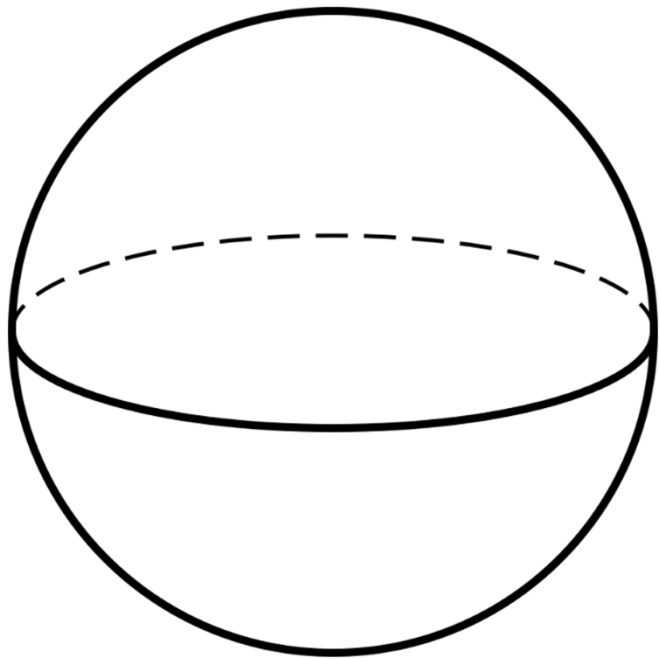

LA BOULE

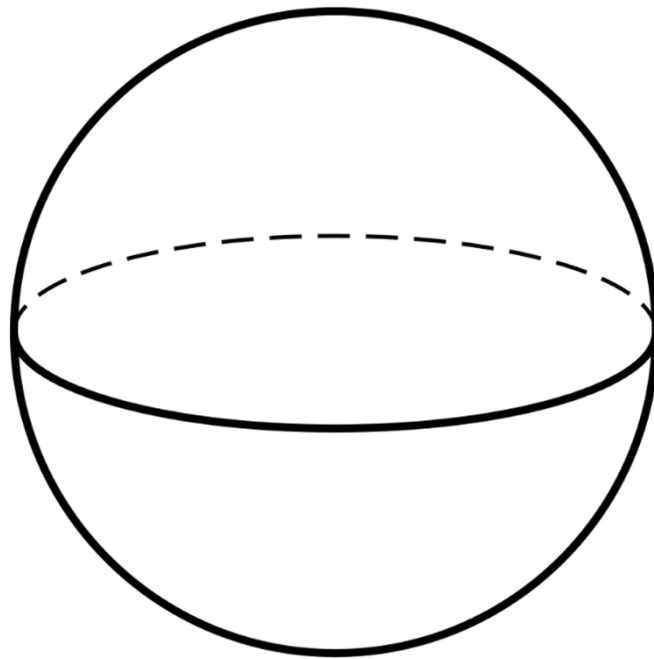

LE CYLINDRE

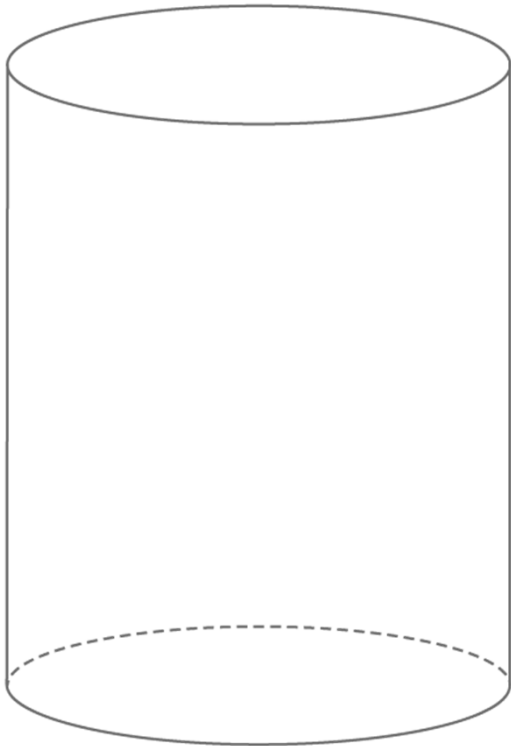

LE CYLINDRE

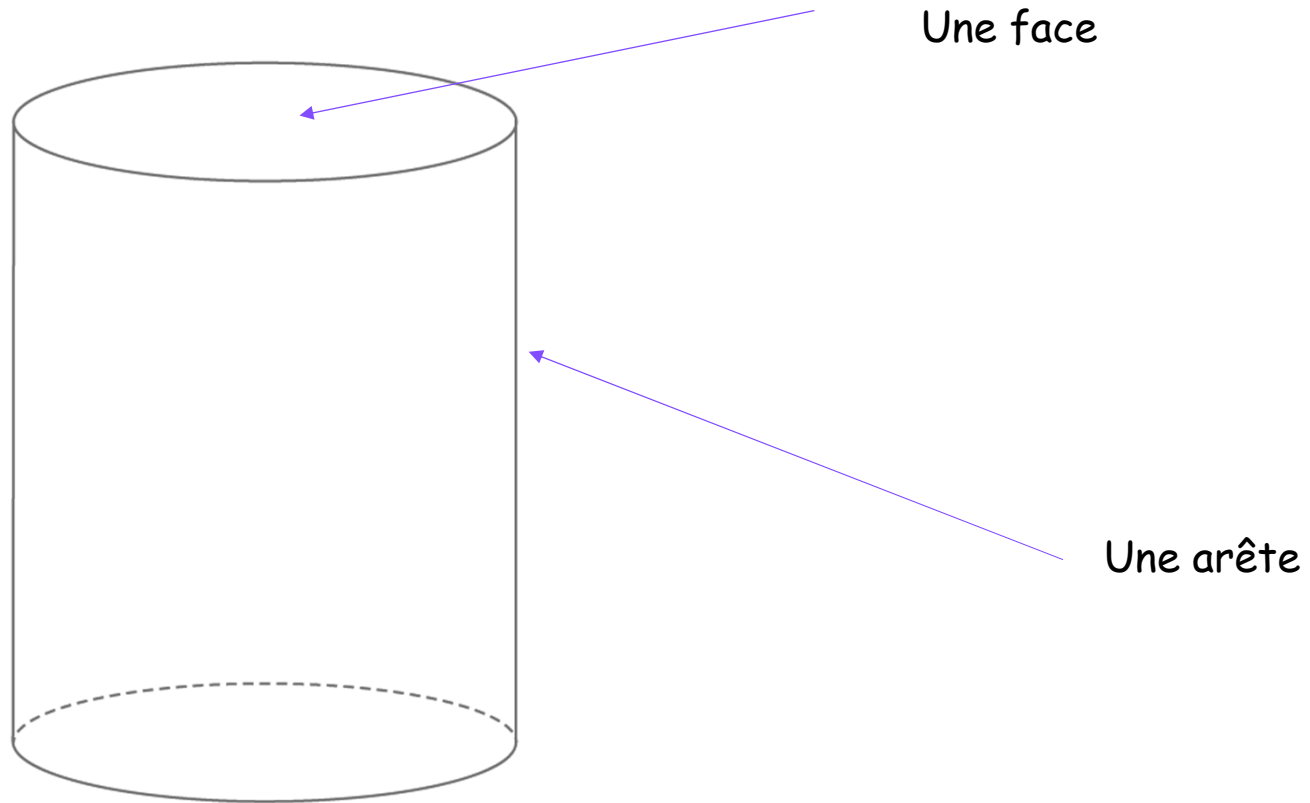

LA PYRAMIDE

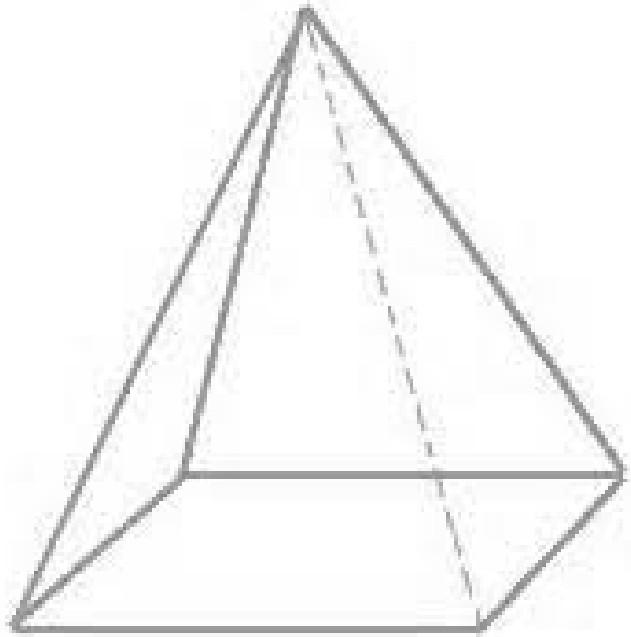

LA PYRAMIDE

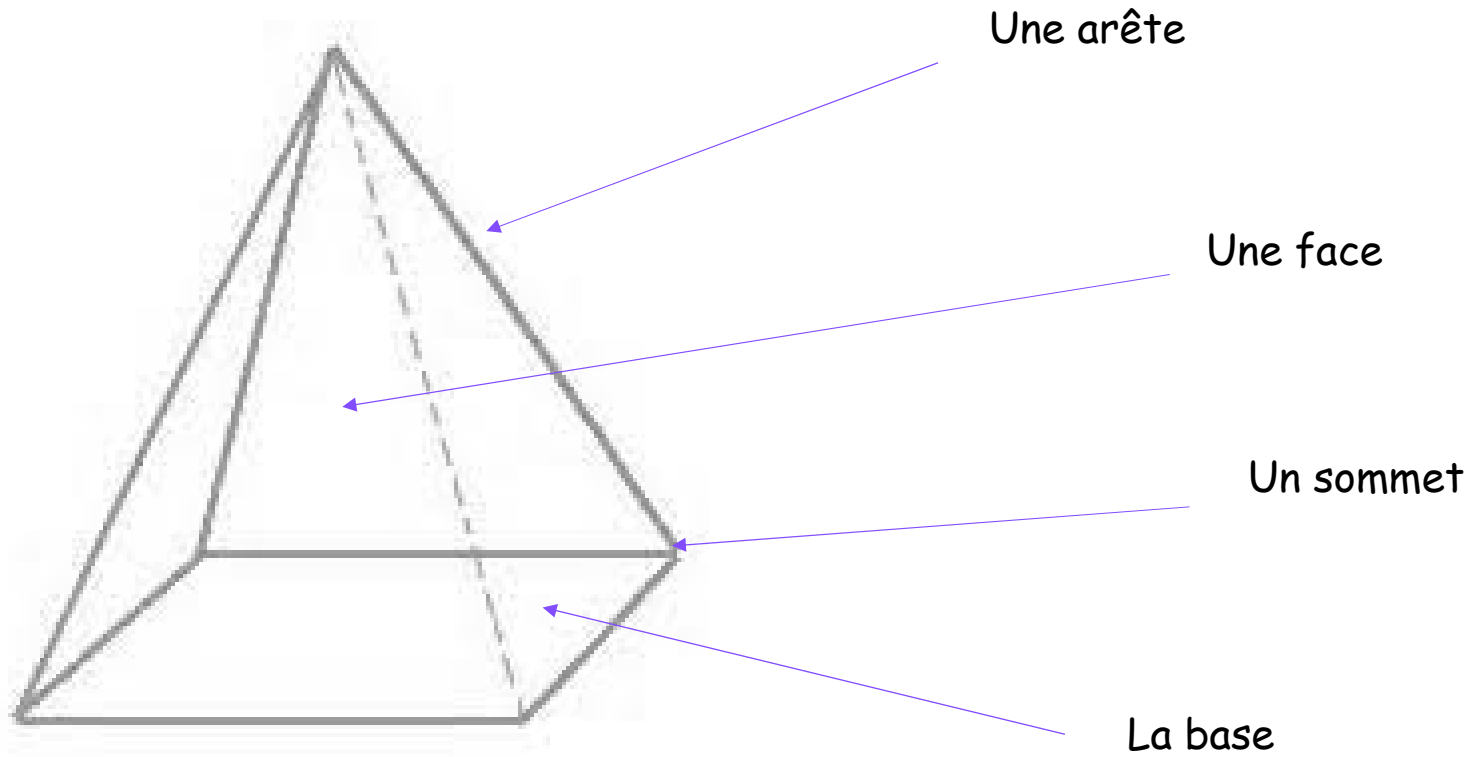

LE CONE

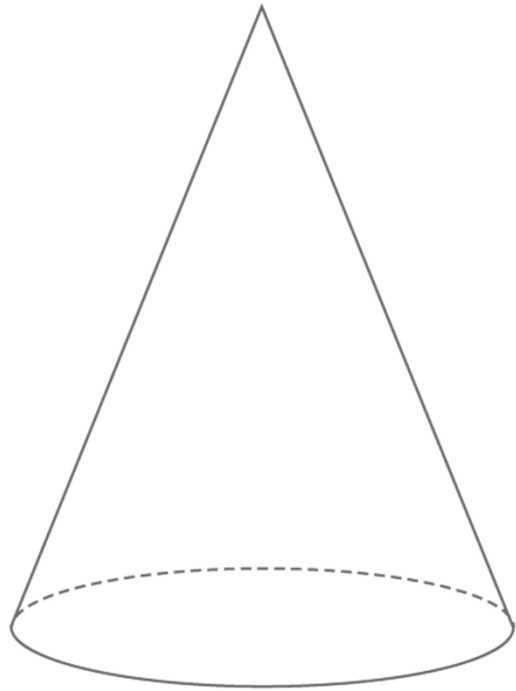

LE CONE

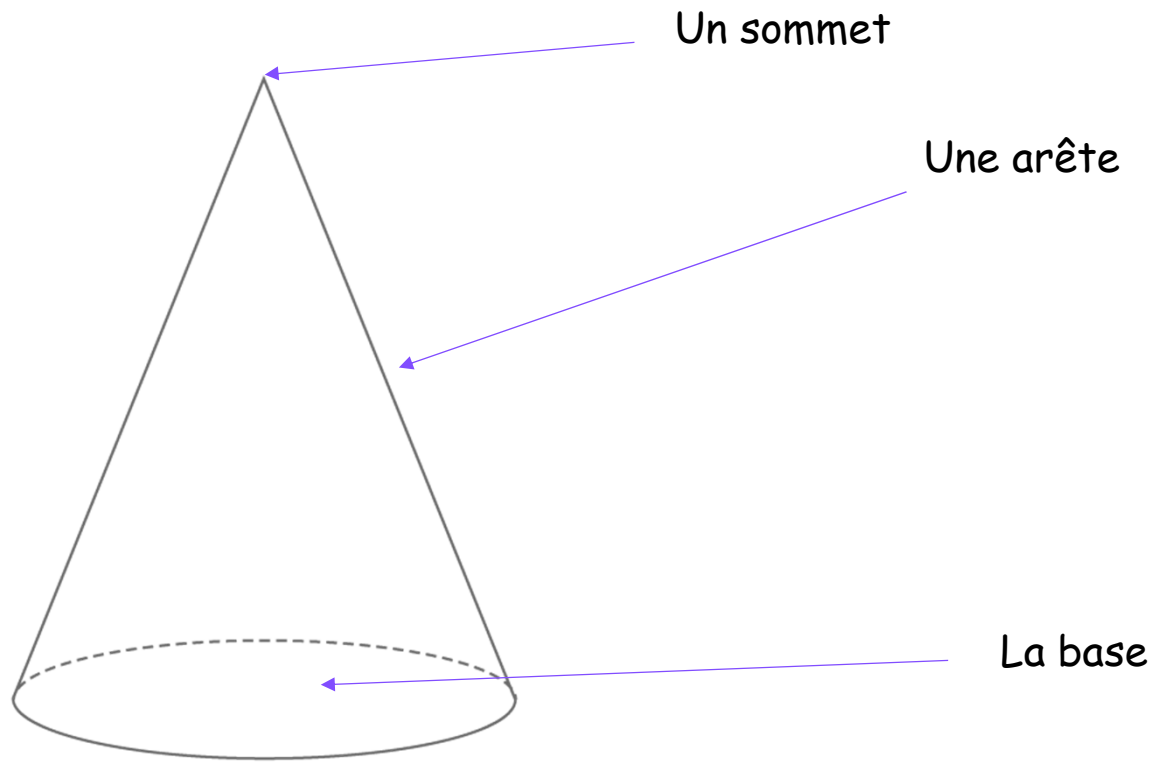

Jeu de Kim

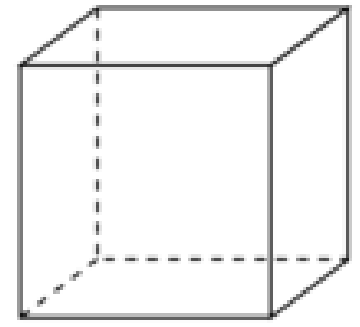
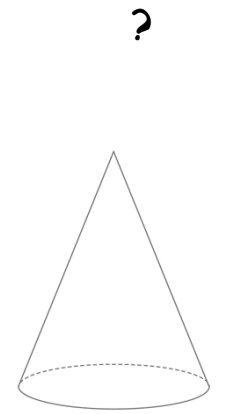
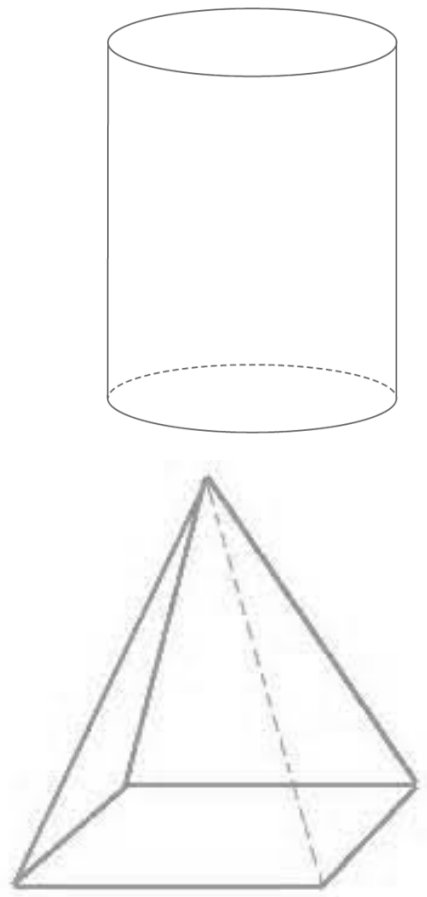

?

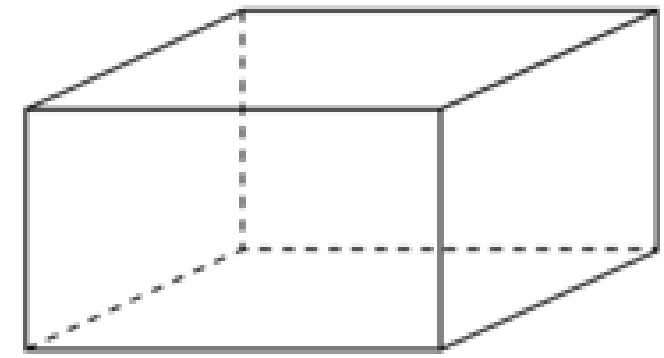
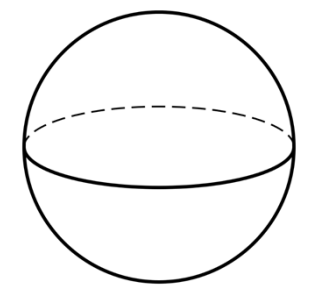

Diapositive 14

II1

loirelei lemerre; 16/05/2020

Que manque t-il ?

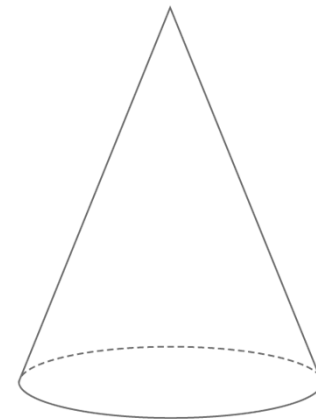
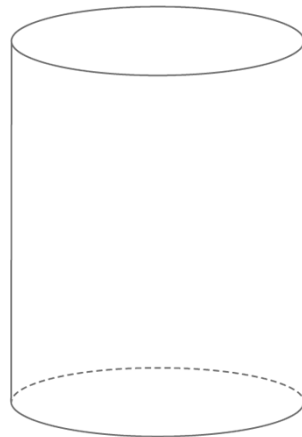
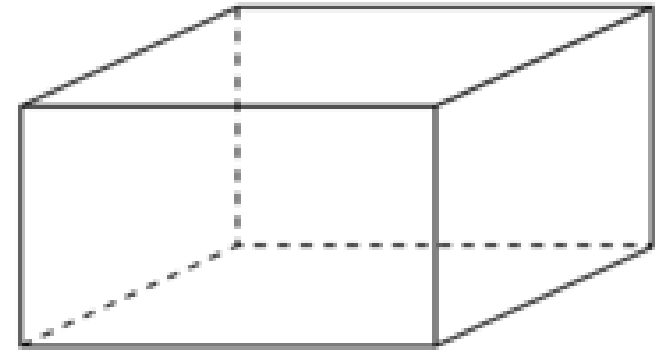
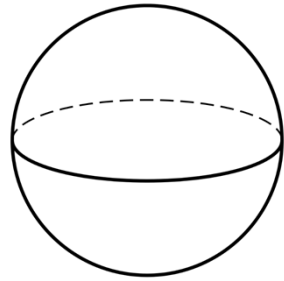
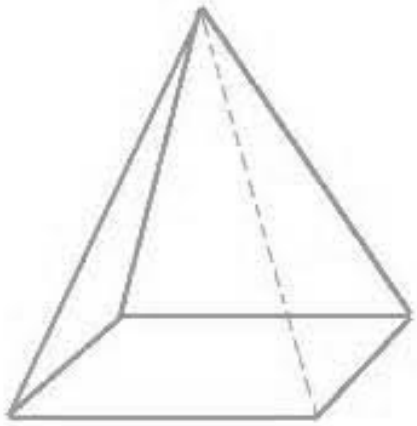

Que manque t-il ?

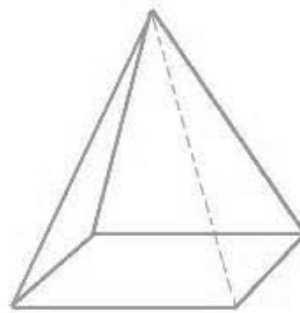
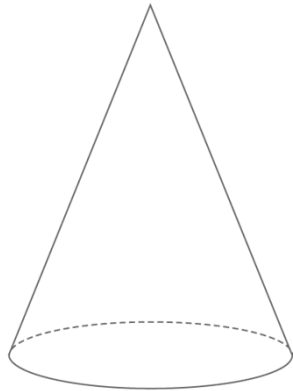
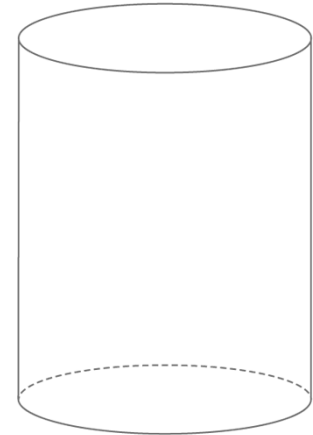
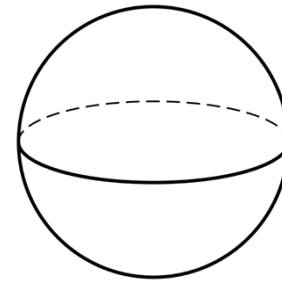
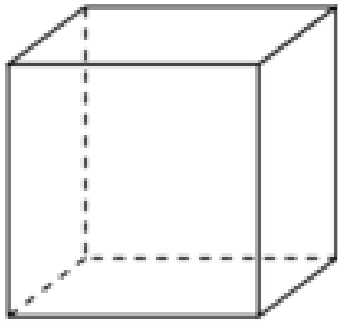

Que manque t-il ?

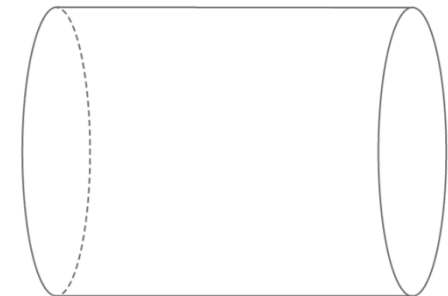
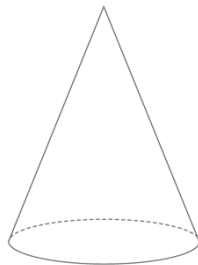
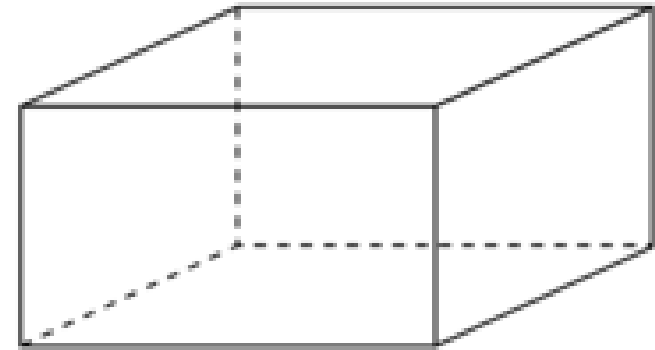
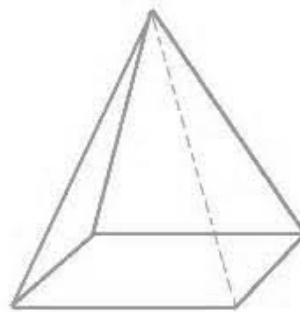
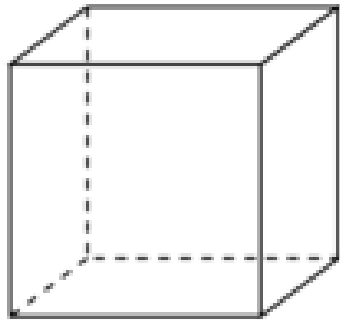

Que manque t-il ?

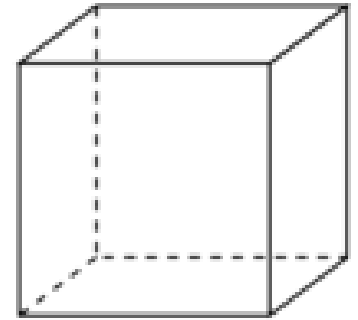
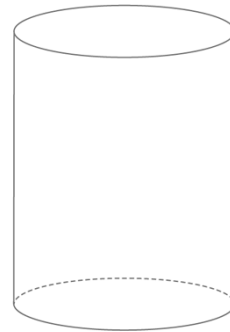
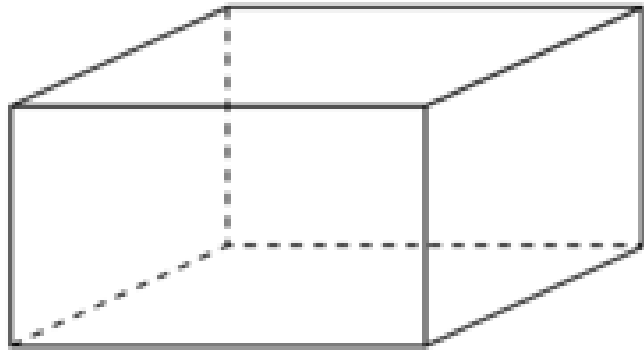

Que manque t-il ?

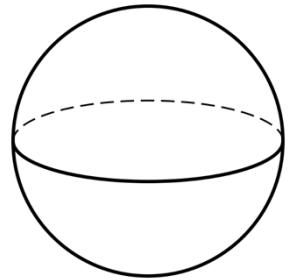
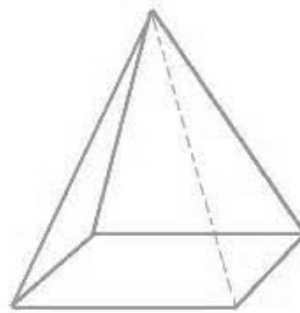
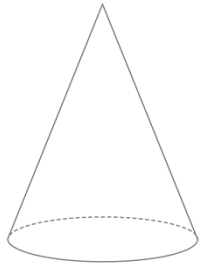
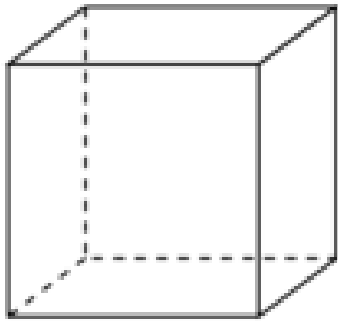

Que manque t-il ?

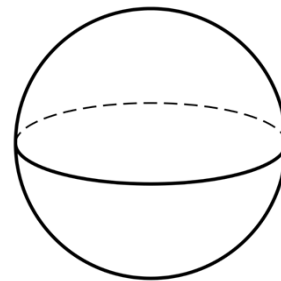
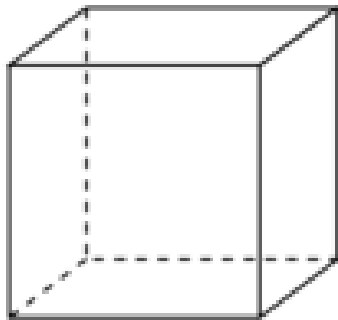
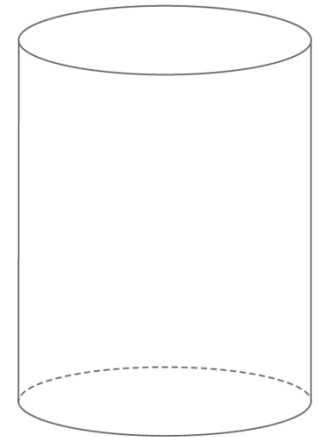
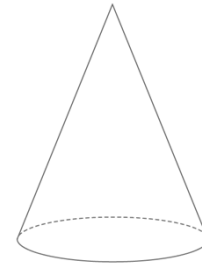
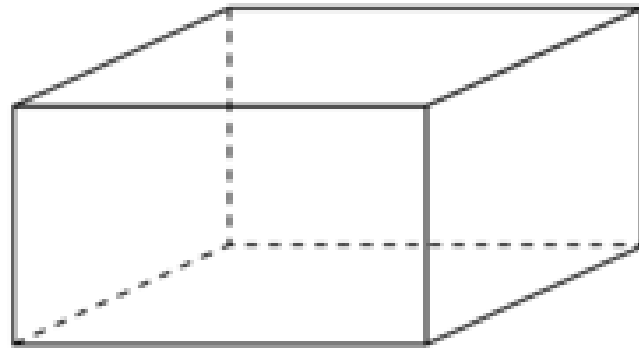

Que manque t-il ?

